

*Elevate your signage to
new heights*

Badger State Industries Sign Catalog



Badger State Industries
3099 East Washington Ave.
Madison, Wisconsin 53704



Buying from BSI can make a real difference.

You are supporting Wisconsin companies, which add to the tax base and employ our taxpaying citizens.

You are helping save taxpayer money through promotion of successful reintegration of offenders into our communities.

You are promoting environmental responsibility through the use of "green" products and development of alternative fuels.

Revenues earned are reinvested in recycling initiatives to keep our landfills safe of pollutants.

Revenues are used to develop meaningful vocational programs for training inmates for release.

You are helping us make our institutions safer by reducing inmate idleness.

Low Prices!

It's Quick and Easy!

One stop shopping for a wide variety of quality products.

Sales Specialists

and Customer Service

John Stolen is the signage salesperson for the State of Wisconsin. Contact John at 608.240.5207 or 608.219.9621(cell) or john.stolen@wisconsin.gov

Marlin Grossholz is the customer service specialist for signage for the State of Wisconsin.

Marlin can be reached at 608.240.5209 or marlin.grossholz@wisconsin.gov

PHONE: 608-240-5200 FAX: 608-240-3321 TOLL FREE: 800-862-1086

W e b s i t e : w w w . b u y b s i . c o m

NIMS National Incident Management System

NIMS signs are available single or double sided. They are offered in two types of substrates, PVC or aluminum.

Each NIMS kit contains:

- ◆ 3-Command Post Signs
- ◆ 1-ERU Sign
- ◆ 1-Outside Agency-Fire
- ◆ 1-Outside Agency-Police
- ◆ 1-Outside Agency-EMS
- ◆ 3-Arrows for attaching to the Command Post Signs (Double sided signs come with 6 Arrows)



We also offer:

ICS Laminated Posters

These 24" x 36" ICS form posters are made of flexible 0.023" white polyblend with Teflon over-laminate. The clear coating allows the instructor/commander to complete with a dry erase marker, erase and reuse the posters.

The Incident Command System (ICS) is a standardized, on-scene, all-hazard incident management concept in the United States. It is a management protocol originally designed for emergency management agencies and later federalized. ICS is based upon a flexible, scalable response organization providing a common framework within which people can work together effectively. These people may be drawn from multiple agencies that do not routinely work together, and ICS is designed to give standard response and operation procedures to reduce the problems and potential for miscommunication on such incidents. ICS has been summarized as a "first-on-scene" structure, where the first responder on a scene has charge of the scene until the incident is resolved or the initial responder transitions incident command to an arriving, more-qualified individual.

Table of Contents

About BSI	3
Highway and Traffic	4
Hydrostripping	5
Interpretative	6
Park & Recreation	7
ATV/Snowmobile	8
Fire Prevention	9
Adopt-a	10
Posts	11
Street Name	12
No Smoking	13
Crime Prevention	13
Interior	14
Exterior	15
Brass Plaques	16
Banners	17
NIMS	18
Contact Information	19

Badger State Industries (BSI) is the Department of Corrections' manufacturing enterprise. BSI operates fourteen industries in eleven different correctional facilities, providing vocational training and work skills development to a willing prison population. BSI can provide a variety of products and services to a limited market of state and local governments, universities and non-profit organizations.

State statutes dictate that BSI be a minimally profitable manufacturing enterprise but our customers need to know that although profit is important, profit for BSI assures funding for the Department's important re-entry program, wheelchair and computer recycling programs, quality equipment upgrades for existing industries and the development of new industries. Badger State Industries is an important piece of the DOC rehabilitative process. Productive inmates can save customers money. Customer support of BSI can save Wisconsin taxpayers money. BSI is proud to offer high quality products and services at very competitive prices.

In fact BSI currently holds state procurement contracts for a variety of products that are detailed in this information sheet. Often county and local governments can purchase off these contracts, avoiding the lengthy, and expensive, bidding process.

Help us make a difference!

Highway and Traffic

We offer hundreds of different highway and traffic signs. Each sign is screened on High Intensity Prismatic sheeting and is available in new or recycled aluminum. There are 5 different types of highway and traffic signs: Regulatory, Warning, Construction, Route Markers and Informational.



Banners



Weight	Usage	Edge	Printed Sides	Grommets	Misc
10 oz Light Weight	Interior	Not Hemmed	One	Yes	
13 oz Light Weight	Interior/Exterior	Not Hemmed	One	Yes	
Heavy Duty	Interior/Exterior	Not Hemmed	One	Yes	Non-flammable



Brass Plaques

Why buy a bronze plaque?

Our bronze plaques stand the test of time - they last virtually forever!
 Available in a wide range of sizes, shapes and finishes - utilizing logos, artwork or pictures
 Vandal-resistant - can be repaired and refurbished to factory new appearance
 Timeless and Elegant - bronze plaques provide an image of prestige and permanence



Hydrostripping Recycle/Reuse

Badger State Industries knows that maintaining an effective and safe road system for pedestrians, bicycles, and motor vehicles is an exhaustive challenge for transportation officials around the world. Traffic congestion, road conditions, and information signs demand their attention. And the cost of maintaining quality signage is rising. Badger State Industries decided to take on the problem of rising signage costs by investing in a cost-efficient and environmentally friendly Hydrostripping system. The result is an innovative and economical solution for saving tax revenue *and* natural resources.

Hydrostripping is a revolutionary method of removing all grades of reflective sheeting from signs of all shapes and sizes, utilizing ultra-high pressure waterjet technology. This environmentally friendly system does not use chemicals or sanding belts, nor does it produce any hazardous waste. In addition, Hydrostripping does not harm the corrosion resistant coatings that have previously been applied to the sign blank. The refurbished sign blanks are ready for re-facing and produce extensive savings over the cost of buying new aluminum. Hydrostripping is endorsed and certified by all of the major reflective sheeting manufacturers.

The Wisconsin DOT has been BSI's partner in the development of the Hydrostripping industry. State regional offices are established collection sites. Consider joining BSI's growing list of state, county and municipal customers that are saving real money with refurbished sign blanks.

Refurbish, Recycle, Reuse. Call it whatever you want, the Hydrostripping process is the perfect environmental and fiscal answer for rising sign costs. Energy and natural resource consumption are minimal in comparison to using new aluminum. Everybody knows, replacing worn and damaged signs with new reflective sheeting materials provides increased safety for motorists and pedestrians alike. Refurbishing, Recycling, and Reusing sign blanks with the Hydrostripper system is a cost-effective method for saving money and conserving natural resources.



Interpretive

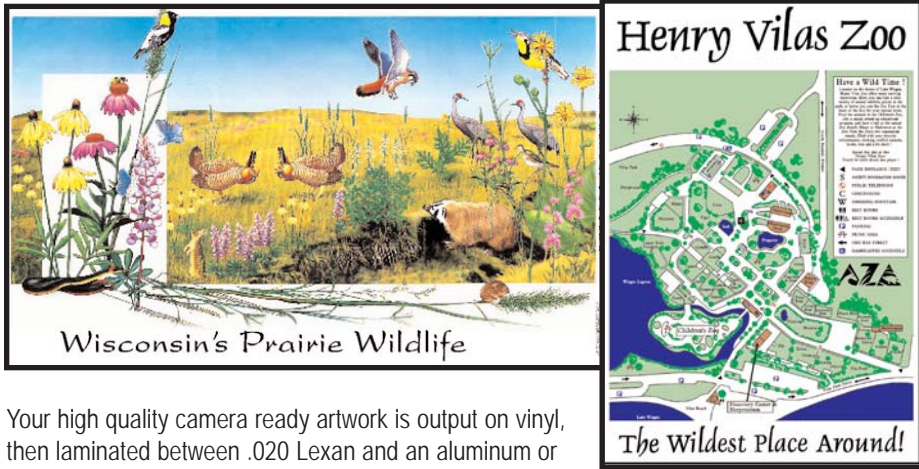

Your high quality camera ready artwork is output on vinyl, then laminated between .020 Lexan and an aluminum or PVCA backing (Aluminum backing is .080 aluminum PVCA backing in customer choice of .125" or .25" PVCA) with high pressure rollers. These signs, designed for outdoor use, are UV resistant, vandal resistant, nonreflective and are excellent for detailed, high quality artwork. **For Indoor use**, medium protection, 2 mils thick film overlaminate is applied instead of Lexan.

Laminated signs are standard with square corners and without mounting holes **NOTE:** If mounting holes are required, please, specify so on the order. Holes drilled by the customer will damage the integrity of the sign and void any warranty

Sign sizes are always expressed as Width X Length and are available in sizes up to 36"x36"

We also offer Sign Frames

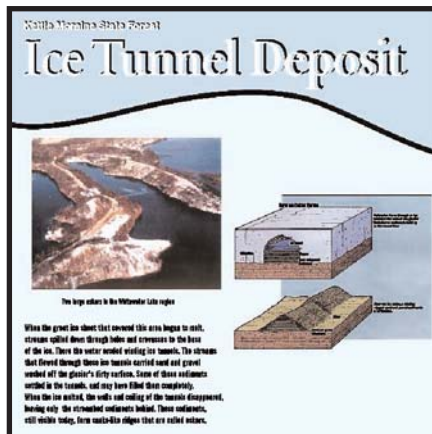
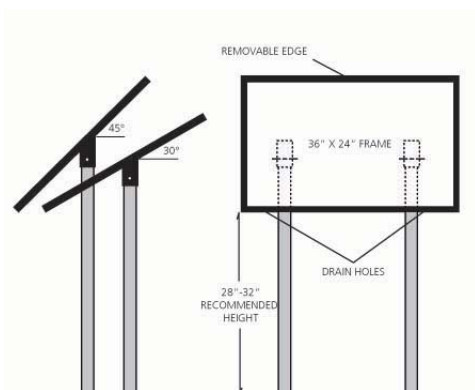

Exterior

We offer many different types of exterior signs:

- ◆ Monument
- ◆ Post and Panel
- ◆ Pan
- ◆ Dimensional Cut-outs
- ◆ LED

We also offer custom design services



Interior

We offer many different types of interior signs:

- ◆ Lock Signs
- ◆ Systems 290
- ◆ ADA
- ◆ Custom Acrylic



Sign families can be customized to meet your needs!



Park and Recreation

All park and recreational symbol signs are aluminum substrate with engineer grade reflective sheeting. The standard color for park and recreational signs is brown. Optional colors are red, green or blue. The not allowed symbol is available with black on white with red "not allowed" symbol.

There are six different types of Recreational symbols:

- ◆ Facility
- ◆ Accommodations
- ◆ Water Recreation
- ◆ Land Recreation
- ◆ Winter Recreation
- ◆ General Recreation

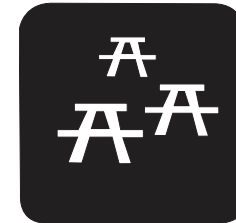

RS-309 Group Picnicking



RS-028 Handicapped



RS-061 Swimming



RS-064 Horse Trail



RS-052 Snowmobiling

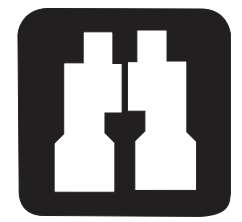

M1-88 Wildlife Viewing

We offer numerous trail signs on a variety of substrates, colors and sizes.



TR-002



TR-003

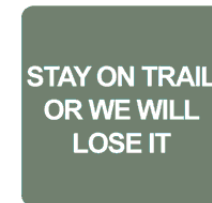

TR-010



TR-028



TR-016



TR-021



TR-027



TR-007

ATV/Snowmobile



W11-21ATV Route
24" x 18"



ATV-1 ATV Trail Marker
6" x 6"



ATV-2 No ATV Permitted
12" x 12"



ATV-3 ATV Crossing
30" x 30"



ATV-4 ATV Crossing
30" x 30"

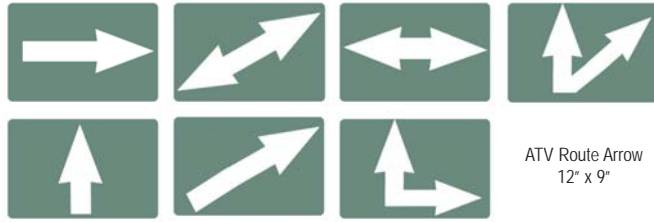

ATV Route Arrow
12" x 9"

**We have Snowmobile and
ATV signs for every trail!**



ATV17 MPH
12" x 18"

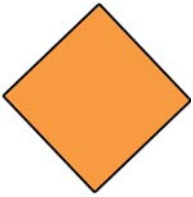

SN1-1 Trail Blazer
6" Diamond



SN2-1 Trail Marker
9" Diamond



SN19-1 Snowmobiling Permitted
12" x 12"



SN20-1 No Snowmobiling
12" x 12"



SN18-1 Trail Symbol
13" x 10.5"



SN12-1 Snowmobile Route
24" x 18"



SN17-1 MPH
12" x 18"



SN7-1 Snowmobile Crossing
30" x 30"



SN7-1 Snowmobile Crossing
30" x 30"



SN22-4 Corridor
6" x 6"



SN15 Barrier Gate Marker
36" x 8"



SN14 Bridge Plaque
6" x 12"

No Smoking



NO
SMOKING



PLEASE
No Smoking in
the Job Center



Wisconsin smoking ban July 5th, 2010



We offer many different types of No Smoking signs for different applications. No Smoking signs can be customized to fit your needs.

Crime Prevention

Badger State Industries offers two different types of Crime Prevention signs, The Generic Eye and The Neighborhood Watch signs. We offer vinyl decals, yard signs, bumper stickers, window stickers and reflective aluminum signs in the Generic Eye and only reflective aluminum for the Neighborhood Watch. The Neighborhood Watch signs can be customized to have your city logo put in the upper right corner. The words "Welcome To Our Community" will be color match to your logo.



Street Name Signs



- ◆ High grade aluminum substrate (base material)
- ◆ Top quality engineer grade reflective sheeting is standard
- ◆ Standard colors are Black, non-reflective, letters on White reflective background and White reflective letters on a Green reflective background. Other color combinations also available for an upcharge. Logos can be added to street names signs

- ◆ Easy to read upper case letters are standard
- ◆ Choice of flat .080 aluminum or heavier duty aluminum extrusion
- ◆ Sign length determined by shop based on length of street name
- ◆ High Intensity sheeting upgrade available on flat blade signs only.
- ◆ Mounting hardware, posts and individual sign blanks can be purchased separately (See Page 17)



Badger State Industries can customize any sign to meet your needs. We offer a wide variety of materials such as, aluminum, PVC, masonite, and more. We can use custom artwork created by you, or our design staff can create designs specifically for you. Contact our sales department for more information.

Fire Prevention

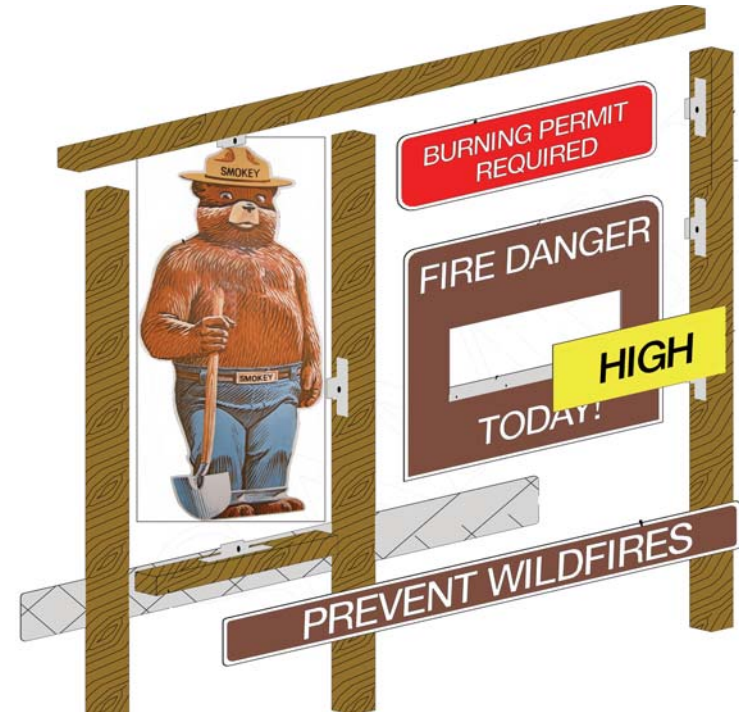

This Smokey the Bear kit comes with everything you need to help prevent wildfires. Smokey the Bear is ink jetted on High Intensity Sheeting and is 72" tall. The sign kit comes with all the signs shown above (wood is not included). The window sign come with 5 danger levels: EXTREME, VERY HIGH, HIGH, MODERATE and LOW. The kit also comes with a steel box to store your signs. This is an all-in-one kit to create your Smokey the Bear Fire Prevention Sign.

123456

Badger State Industries also offers Farm Fire Control Signs. These signs are available in aluminum in two different sizes: 17x6 and 8X24. For Fire Control Sign posts see page 17.

Adopt-a-



Adopt-a-Highway signs can be seen on many Wisconsin roadways. These seven color signs are screened on High Intensity Prismatic sheeting on top of aluminum.

Other Adopt-a signs include:

- ◆ Adopt-a-Trail
- ◆ Adopt-a-Lake
- ◆ Adopt-a-Road
- ◆ Adopt-a-Boat Landing
- ◆ more...

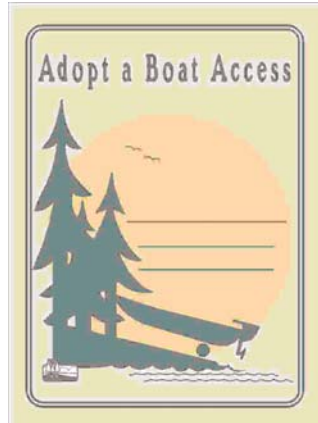

Adopt-a- signs can be customized to include a sponsor name.

Posts

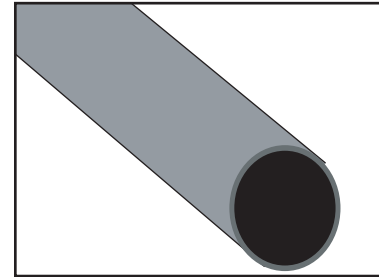

Round Tubular Posts

TP-1100G 10' Post 2" Galvanized Structural Steel



MR-1000

Morris Ring unit for mounting single sided signs to TP-1100G, 2 units required per sign

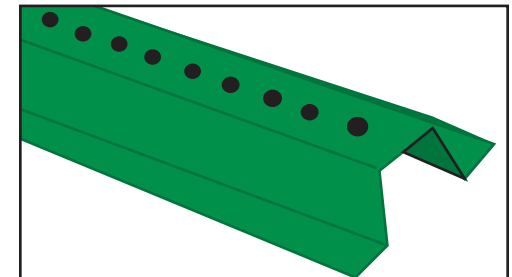

Standard Steel Flanged Channel Posts

FP-1060	6' Post, Holes 1" on Center
FP-1080	8' Post, Holes 1" on Center
FP-1100	10' Post, Holes 1" on Center
FP-1120	12' Post, Holes 1" on Center

Lightweight Steel Flanged Channel Post

FP-1066	6'-6" Post, Holes 1" on Center
---------	--------------------------------



Carsonite Composite Posts

For more information on Carsonite posts please call a sales representative.